

MKP RADIAL POTTED CAPACITORS

Pitch 15.0/17.5 mm

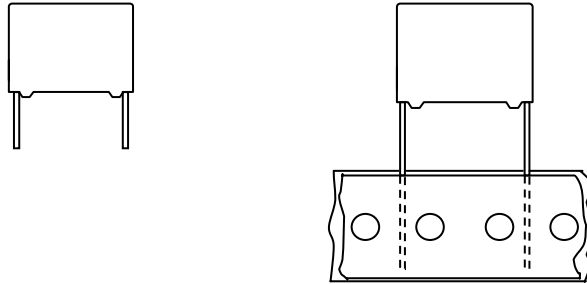

P = 15.0 / 17.5mm

QUICK REFERENCE DATA

Capacitance value	0.033, 0.047, 0.068, 0.1, 0.15, 0.22 μ F
Capacitance tolerance	$\pm 20\%$
Resistance value	22 Ω , 47 Ω , 120 Ω
Resistance tolerance	$\pm 10\%$
Rated (AC) voltage 50 to 60 Hz	250 V \sim
Climatic category	40/085/21
Temperature range	-40 $^{\circ}$ C ~ +85 $^{\circ}$ C
Reference IEC specification	IEC 60384-14
Safety approvals	UL60384-14 & CSA E60384-14:09(cUL) VDE, EK
Potting & Encapsulation material	Qualified in accordance with UL 94V-0
Safety class	X2

FEATURES <ul style="list-style-type: none"> . 15.0mm, 17.5mm lead pitch . Supplied loose in box and taped in ammopack . Consist of a low-inductive wound cell of metalized polypropylene film and carbon composition resistor, potted in a flame retardant case 	APPLICATIONS <ul style="list-style-type: none"> . For X2 – electromagnetic Interference suppression . Spark quenching . Noise suppression
---	---

- Please refer to caution and warning at <http://www.pilkor.co.kr/download/Introductions.pdf> before using these products.

Ordering Information

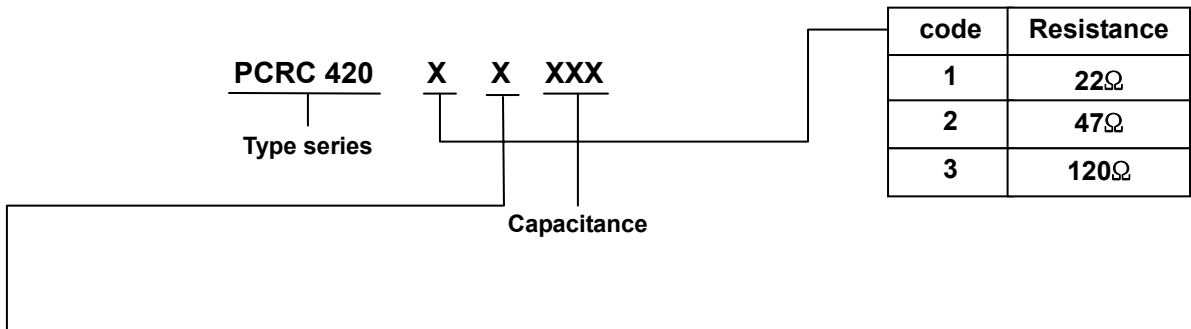
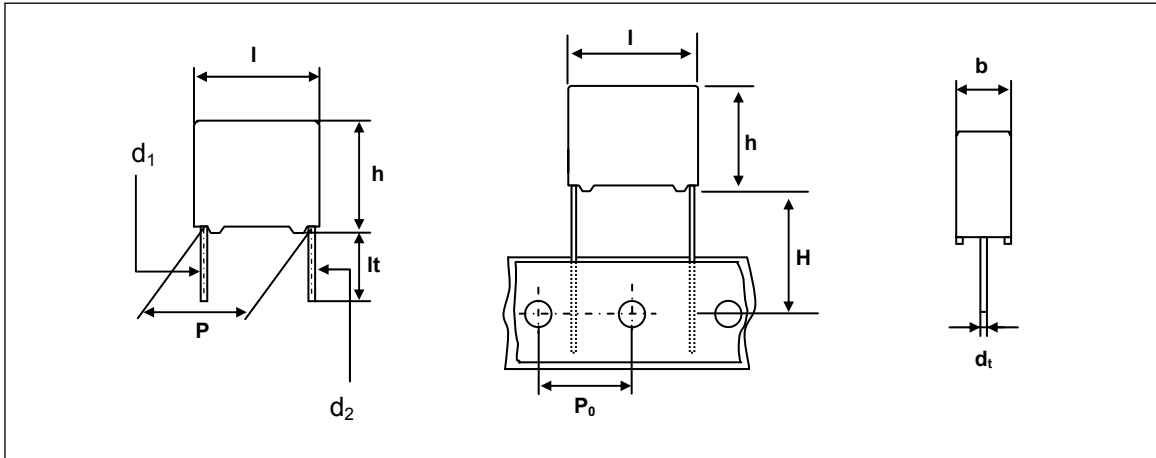

code	Packing method	Lead configuration	C – tol, R - tol	12NC**
1	Loose in box	lt = 4.0 ± 1.0mm	C-tol ±20% & R-tol ±10%	PCRC 420 x1xxx
2	Loose in box	20 < lt ≤ 25mm	C-tol ±20% & R-tol ±10%	PCRC 420 x2xxx
3	Ammopack	H = 18.5 mm / P ₀ =12.7mm	C-tol ±20% & R-tol ±10%	PCRC 420 x3xxx
4	Ammopack	H = 18.5 mm / P ₀ =15.0mm	C-tol ±20% & R-tol ±10%	PCRC 420 x4xxx

** Some values do not follow coding rule.

EMI Suppression film capacitors (RC unit)

PCRC 420

SAFETY APPROVALS

SAFETY APPROVALS	Voltage	Value	File Number
UL 60384-14 & CSA E60384-14:09(cUL)	250V(AC)	33nF to 220nF + 22 Ω , 47 Ω , 120 Ω	E165646
VDE	250V(AC)	33nF to 220nF + 22 Ω , 47 Ω , 120 Ω	120831
EK	250V(AC)	33nF to 220nF + 22 Ω , 47 Ω , 120 Ω	SH03001-2004

Packaging Information

SMALLEST PACKING QUANTITIES (SPQ)	LOOSE IN BOX	
DIMENSIONS	lt = 4 \pm 1.0 mm	20 < lt \leq 25 mm
8.5 x 15.0 x 18.0	1000	1000
10.0 x 17.5 x 18.0	1000	1000
8.0 x 17.0 x 22.0	1000	1000
9.0 x 17.5 x 22.0	500	500
10.5 x 18.5 x 22.0	500	500

EMI Suppression film capacitors (RC unit)

PCRC 420

SPECIFIC REFERENCE DATA FOR 250 V_{AC}

Tangent of loss angle	Frequency		at 1 khz		
	Value (Cap. + Res.)				
	Resistance (Ω)		22	47	120
	Capacitance (μF)	0.033 ~ 0.047	< 1.5%	< 3%	< 6%
		0.068 ~ 0.1	< 3%	< 5%	< 10%
		0.15 ~ 0.22	< 5%	< 10%	< 20%
Rated voltage pulse slope (dV/dt) _R			100 V/μs		
R between leads, for all value			> 30 000 MΩ		
Test voltage (DC) on line;			2250V, 1min		
Withstanding(AC) Voltage between leads and case			2400 V ; 1 min		

V_{Rac} = 250 V

Cap. (μF)	Combination Resistance (Ω)	b x h x l (mm)	CATALOGUE NUMBER		
			PCRC 420		
			loose in box		
			It = 4.0 ± 1.0 mm	20 < It ≤ 25 mm	
			C - tol ; ± 20 % & R - tol ; ± 10 %		
Pitch = 15.0 ± 0.5 mm		d ₁ = 0.8 +0.08/-0.05 mm, d ₂ = 0.7 +0.08/-0.05 mm			
0.033	22	8.5 x 15.0 x 18.0	11333	12333	
	47		21333	22333	
	120		31333	32333	
0.047	22		11473	12473	
	47		21473	22473	
	120		31473	32473	
0.068	22		11.0 x 19.0 x 18.0	11683	12683
	47			21683	22683
	120			31683	32683
0.1	22	11A04		12A04	
	47	21A04		22A04	
	120	31A04		32A04	
Pitch = 17.5 ± 0.5 mm		d ₁ = 0.8 +0.08/-0.05 mm, d ₂ = 0.7 +0.08/-0.05 mm			
0.1	22	8.0 x 17.0 x 22.0		11104	12104
	47			21104	22104
	120		31104	32104	
0.15	22	9.0 x 17.5 x 22.0	11154	12154	
	47		21154	22154	
	120		31154	32154	
0.22	22	10.5 x 18.5 x 22.0	11224	12224	
	47		21224	22224	
	120		31224	32224	

Example : 68 nF + 120 Ω (It = 4 ± 1.0 mm) → code number : PCRC 420 31683

CONSTRUCTION

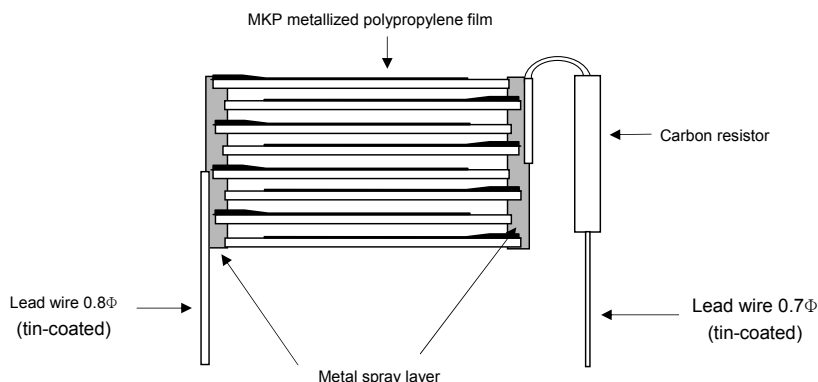

MOUNTING

NORMAL USE

The capacitors are designed for mounting on printed-circuit boards.

The capacitors packed in bandoliers are designed for mounting on printed-circuit boards by means of automatic insertion machines.

For detailed specifications refer to chapter "PACKAGING".

SPECIFIC METHOD OF MOUNTING TO WITHSTAND VIBRATION AND SHOCK

In order to withstand vibration and shock tests, it must be ensured that the stand-off pips are in good contact with the printed-circuit board.

- For pitches of 15.0mm the capacitors shall be mechanically fixed by leads.
- For pitches of 17.5mm the capacitors shall be mounted in the same way and the body clamped.

SPACE REQUIREMENTS ON PRINTED-CIRCUIT BOARD

The maximum length and width of film capacitors are shown in the following drawing ;

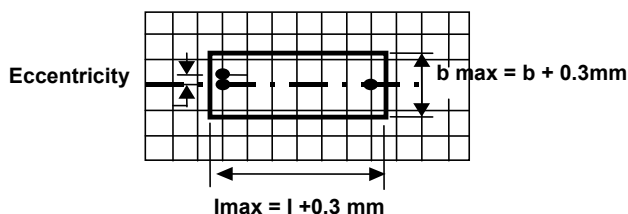

- Eccentricity as in drawing.

The maximum eccentricity is smaller than or equal to the lead diameter of the product concerned.

- Product height with seating plane as given by IEC 60717 as reference : $h_{max} \leq h + 0.3mm$

RATINGS AND CHARACTERISTICS

Unless otherwise specified all electrical values apply to an ambient temperature of $23 \pm 1^\circ\text{C}$, an atmospheric pressure of 86 to 106KPa and a relative humidity $50 \pm 2\%$.

For reference testing, a conditioning period shall be applied of 96 ± 4 hours by heating the products in a circulating air oven at the rated temperature and a relative humidity not exceeding 20%.

CAPACITANCE

- All capacitance values are specified at 1 kHz. (Vs. Temperature)

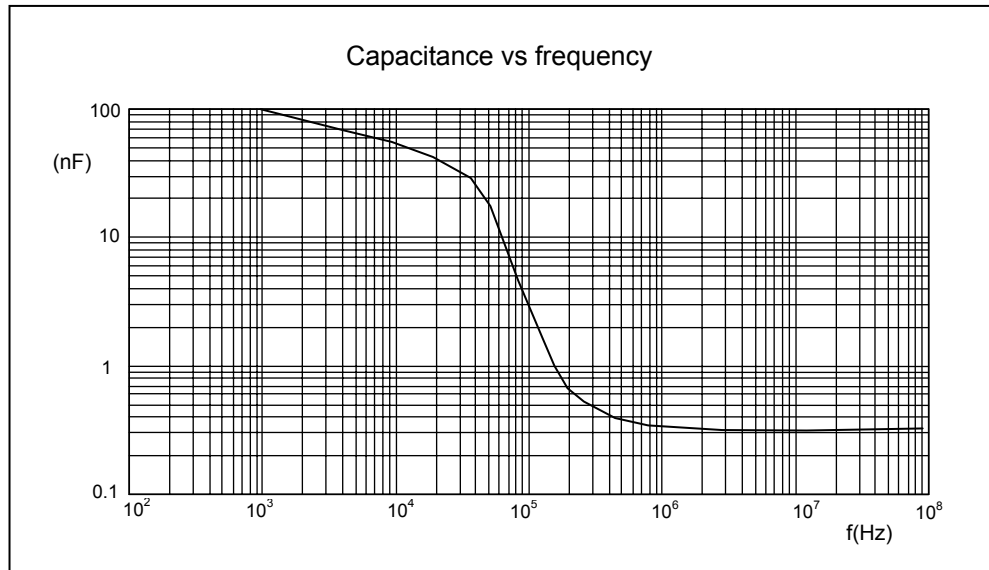

- Capacitance at 25°C (Vs. Frequency) , ex) $100\text{nF}+120\Omega$

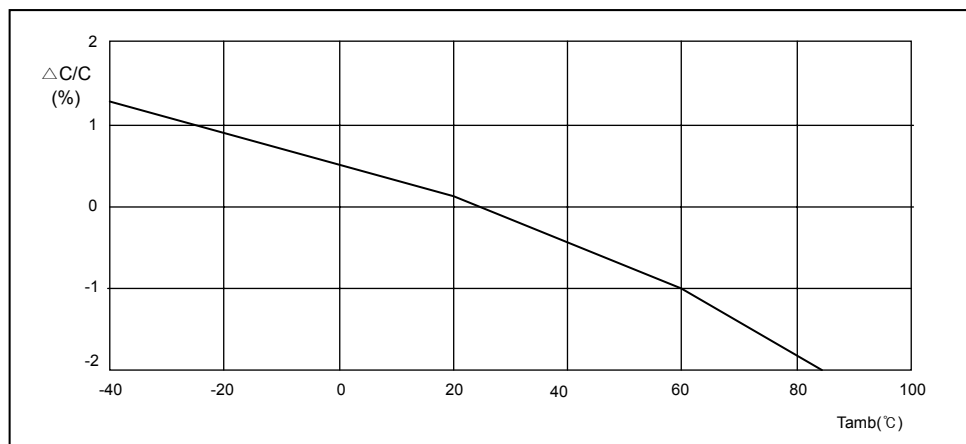

TEMPERATURE

- Storage temperature : $T_{stg} = - 25$ to $+ 40^{\circ}\text{C}$ with RH maximum 80% without condensation.

VOLTAGE

- Test voltage between leads, 100% on line for 1 second : for all value ; 2200V (DC)
- Test voltage between interconnected leads and case (foil method) : 2050V (AC).

DISSIPATION FACTOR

The dissipation factor is measured at 1kHz

INSULATION RESISTANCE

The insulation resistance is measured after a voltage of 100 ± 15 V has been applied for 1 minute ± 5 seconds at $T_{amb} = 20^{\circ}\text{C}$.

- R between leads for all value : $> 30\,000\ \text{M}\Omega$.
- R between interconnected leads and case (foil method) : $> 30\,000\ \text{M}\Omega$.

PRODUCT MARKING

Capacitors are marked with following information;

- 1.Manufacturer (PILKOR)
- 2.Manufacturer's type designation (PCRC 420)
- 3.Rated capacitance
- 4.Rated (AC) voltage (250V~)
- 5.Sub class (X2)
- 6.Tolerance on rated capacitance M = $\pm 20\%$ K = $\pm 10\%$
- 7.Climatic category (40/085/21)
- 8.Code for dielectric material (MKP)
- 9.Resistance value (Ω)
- 10.Year and week of manufacturing (e.g. WK1301)
- 11.Safety approvals

Example of marking

Pitch P = 15.0 / 17.5mm, all value

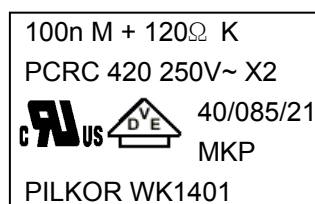

Marking on the side