

EVTC Technology

(Thermally Protected Varistor)



THIS PAGE INTENTIONALLY LEFT BLANK.

EVTC Technology (Thermally Protected Varistor) Features

- High energy handling capability.
- Wide voltage range available: 150VAC – 680VAC.
- Industry standard footprint and wave solderable.
- UL1449 4th Edition and CUL Type 1 Component Assemblies recognized. File #E321567. (Meets SCCR 200KA rating).
- CE Certified
- 50KA or 75KA, 8/20 μ s peak surge current rating.
- RoHS compliant.
- Exceeds industry standard operating and storage temperatures for this type of device. Rated at -40°C to +85° (operating) and -40°C to +125°C (storage).
- Equipped with micro-switch providing diagnostics (if other micro-switch options are required, please contact WPI).
- Patents: USA, Germany, China and Taiwan.
- 94V-0 Enclosure Rating.



Part Numbering System and Part Marking

EVTC 34 V 275 K N 3.8 B N - 75 R
 (1) (2) (3) (4) (5) (6) (7) (8) (9) (10) (11)

(1) Series

EVTC= EV Series Varistor **TC** Thermal Disconnect

(2) Disk Size

34 = 34mm

(3) Type

V = High Current EV Varistor Series

(4) AC RMS Voltage Rating

275 = 275VAC

(5) Tolerance

K = ±10%

(6) Micro Switch

Blank = 3 Lead Type (on top)

M = 2 Lead Type (on top)

P = 3 Lead Type (on bottom)

N = 2 Lead Type (on bottom)

(7) Micro Switch (Special lead size ± 1mm)

1.0 = 1.0mm lead diameter (Narrow base only)

3.8 = 3.8mm lead length (only available for 2 Lead on Top Type & 3 Lead on Bottom Type)

Blank = Standard lead length

(8) Tab Lead (Special lead length ± 1mm - Special lead length types will not include hole in tab lead.)

A = 3.8 mm

B = 10.0mm

C = 5.00mm

(9) Base Width

N = Narrow Base

Blank = Standard Base

(10) High Current

75 = 75kA max current

Blank = 50kA max current (Standard)

(11) Thermal Disconnect Visual Indicator

R = No indicator

Blank = Indicator included

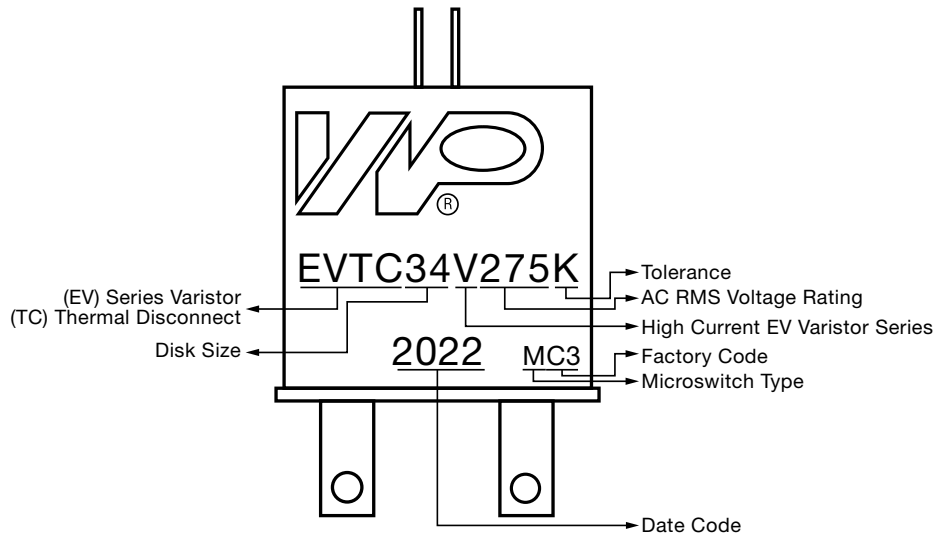

(EXAMPLE)

Date Code (i.e.: 2022 = First two digits represent year (20 = 2020). Remaining digits represent the week of the year (22 = week 22).

CAUTION: BENDING OF BOTTOM LEADS DURING INSTALLATION MAY CAUSE INTERNAL DAMAGE AND WILL VOID MANUFACTURER'S PRODUCT WARRANTY.

EVTC Series – 2 and 3 Lead Micro Switch Type

Electrical Characteristics

PART NUMBER	Maximum Continuous Operating Voltage (MCOV)	Voltage Protection Rating (VPR)	Nominal Discharge Current (In)	Maximum Surge Current (Imax)	Short Circuit Current Rating (SCCR)
	(Vac)	(V)	(kA, 8/20µs)	(kA, 8/20µs)	(kA)
EVTC34V150K	150	600	20	50 or 75	200
EVTC34V180K	180	700			
EVTC34V275K	275	900			
EVTC34V300K	300	900			
EVTC34V320K	320	900			
EVTC34V385K	385	1500			
EVTC34V420K	420	1500			
EVTC34V510K	510	1500			
EVTC34V550K	550	2000			
EVTC34V680K	680	2000			

EVTC Series – 2 Lead Micro Switch (on top) Type

Dimensions (mm)

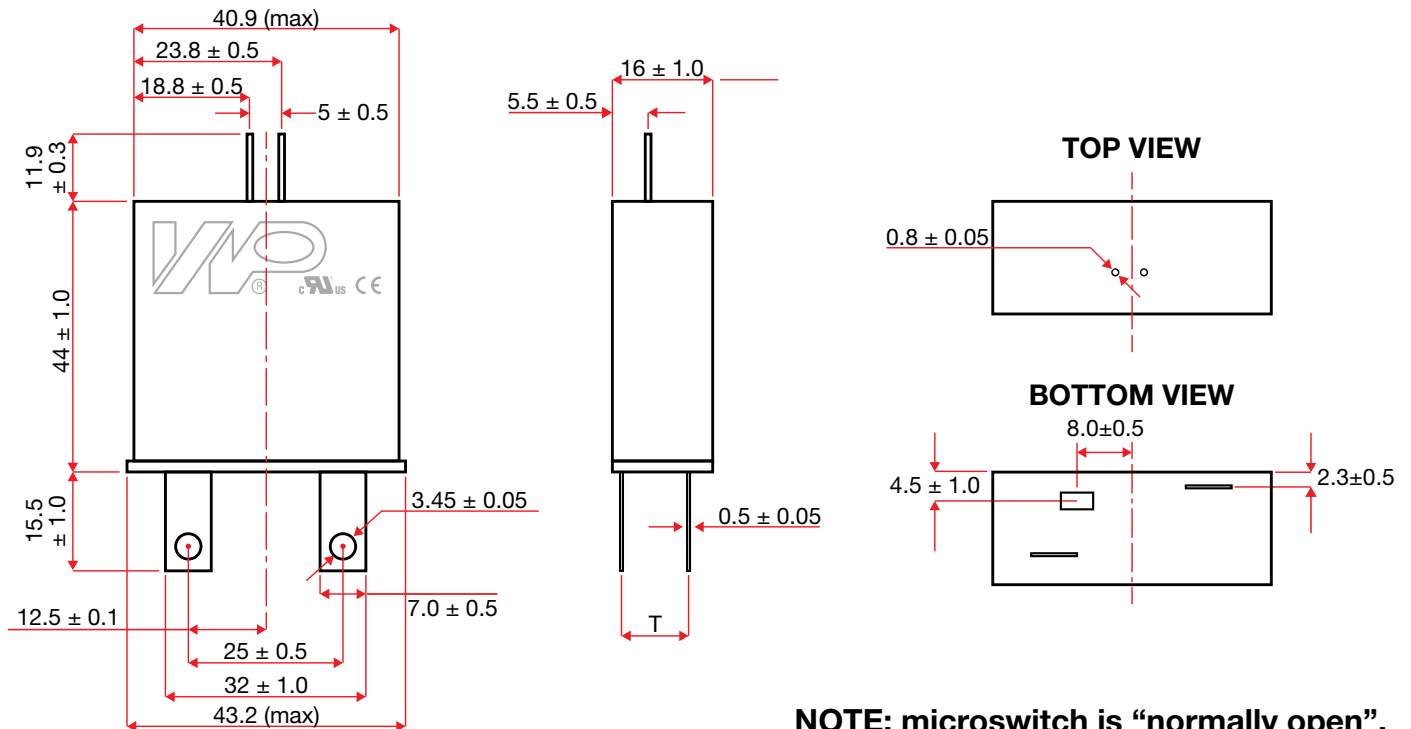

Lead Off-Set

Part Number	T
EVTC34V150	8.6
EVTC34V180	8.6
EVTC34V275	8.8
EVTC34V300	9.2
EVTC34V320	9.2
EVTC34V385	9.8
EVTC34V420	10.0
EVTC34V510	10.0
EVTC34V550	10.1
EVTC34V680	11.3

NOTE: T tolerance is ±0.5.

EVTC Series – 2 Lead Micro Switch (on top) Narrow Base Type

Dimensions (mm)

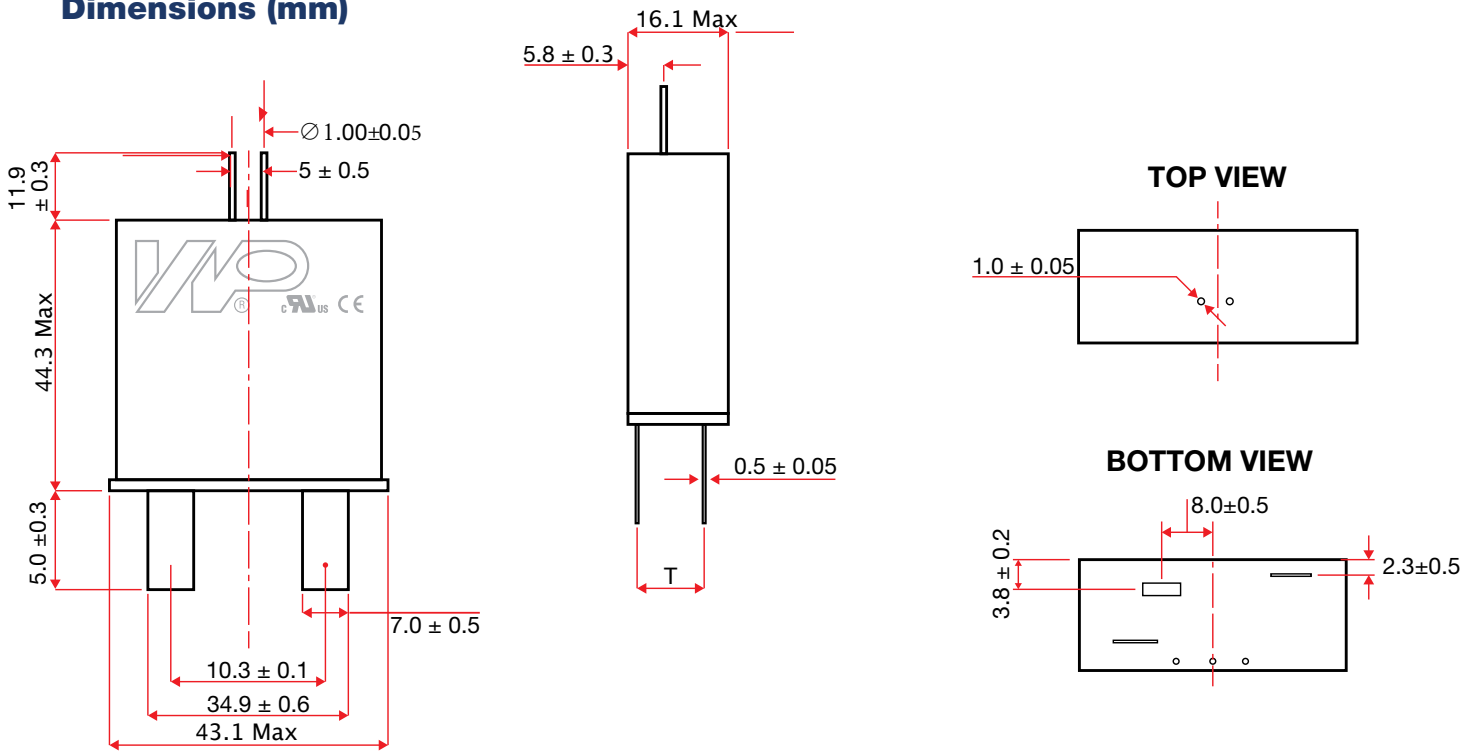

NOTE: Only applicable for 5.0mm tab option

Lead Off-Set

Part Number	T
EVTC34V150	8.6
EVTC34V180	8.6
EVTC34V275	8.8
EVTC34V300	9.2
EVTC34V320	9.2
EVTC34V385	9.8
EVTC34V420	10.0
EVTC34V510	10.0
EVTC34V550	10.1
EVTC34V680	11.3

NOTE: T tolerance is ± 0.5 .

EVTC Series – 3 Lead Micro Switch (on top) Type

Dimensions (mm)

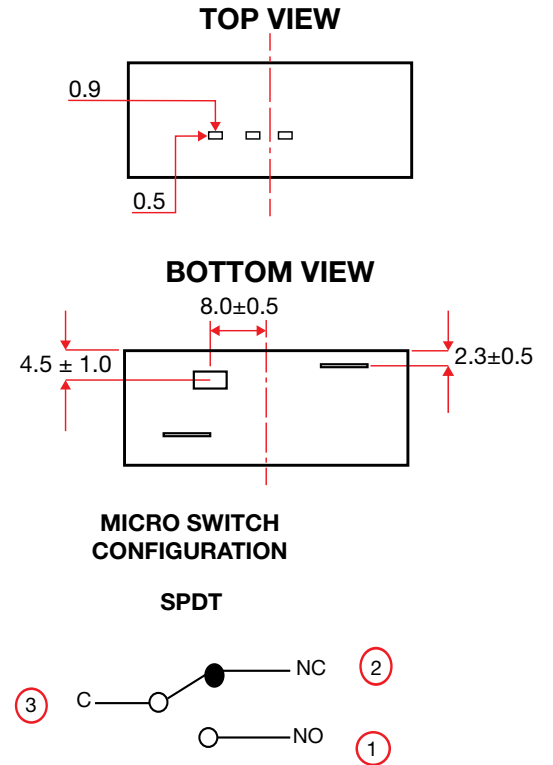
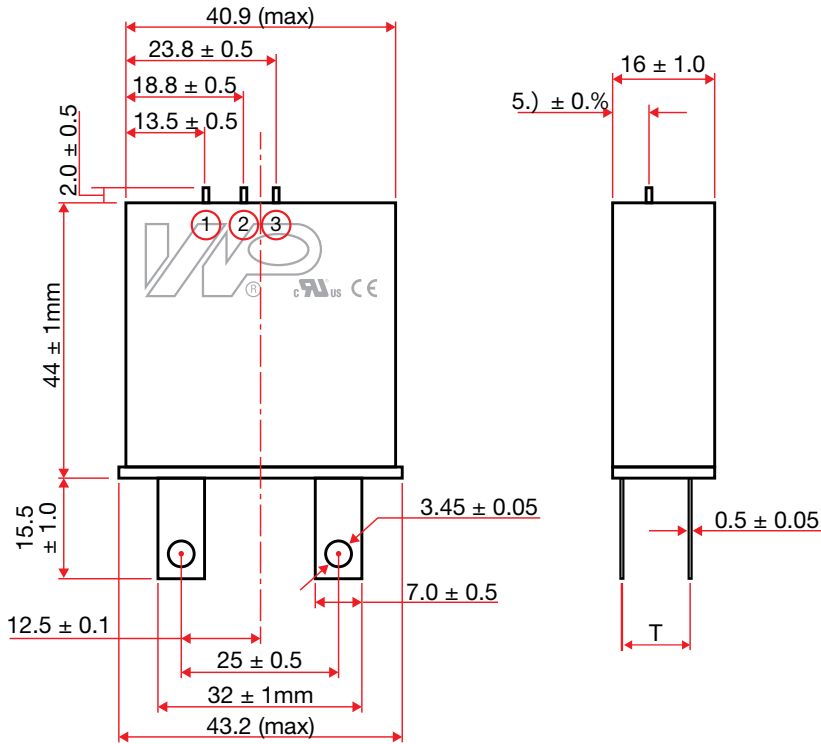

Lead Off-Set

Part Number	T
EVTC34V150	8.6
EVTC34V180	8.6
EVTC34V275	8.8
EVTC34V300	9.2
EVTC34V320	9.2
EVTC34V385	9.8
EVTC34V420	10.0
EVTC34V510	10.0
EVTC34V550	10.1
EVTC34V680	11.3

NOTE: T tolerance is ±0.5.

EVTC Series – 3 Lead Micro Switch (on bottom) Type

Dimensions (mm)

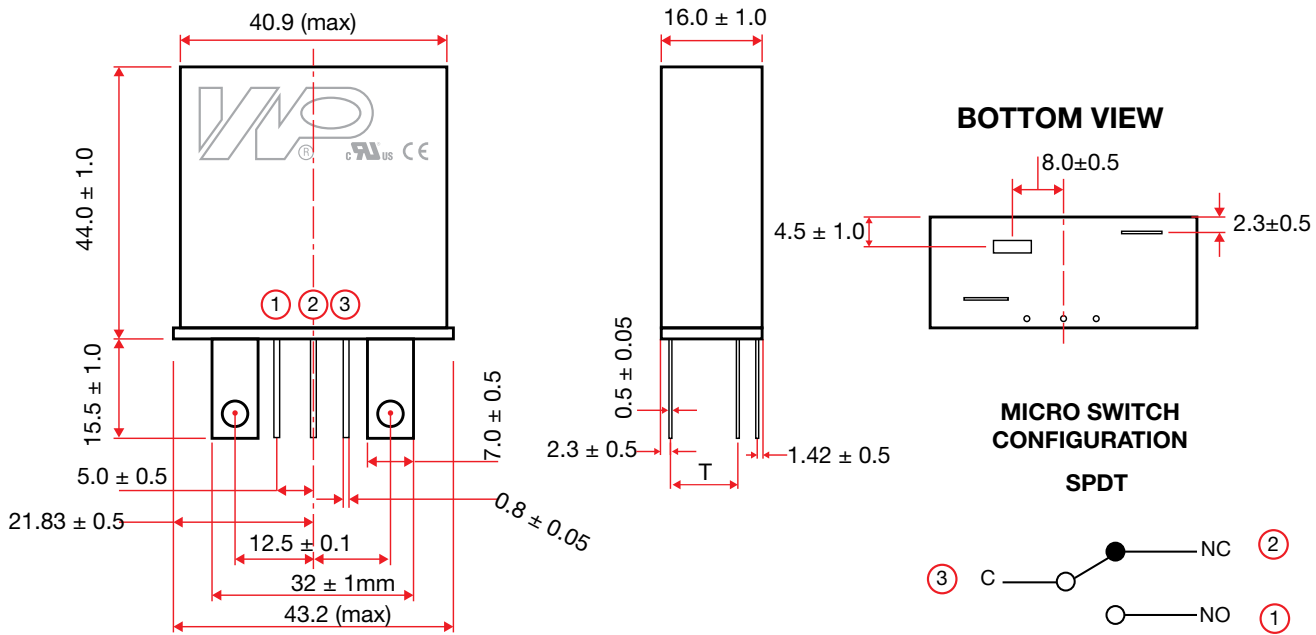

Lead Off-Set

Part Number	T
EVTC34V150	8.6
EVTC34V180	8.6
EVTC34V275	8.8
EVTC34V300	9.2
EVTC34V320	9.2
EVTC34V385	9.8
EVTC34V420	10.0
EVTC34V510	10.0
EVTC34V550	10.1
EVTC34V680	11.3

NOTE: T tolerance is ±0.5.

EVTC Series

Absolute Maximum Ratings

ITEMS	VALUE	UNITS
Operating Ambient Temperature Range (T _A)	-40 ~ +85	°C
Storage Temperature Range (T _{STG})	-40 ~ +125	°C
Temperature Coefficient of Varistor Voltage (V _n) at Specified Test Current	< 0.05	%/°C
Hi-Pot Encapsulation (Isolation Voltage Capability)	2500	V
Isolation Voltage Capability (when the thermal disconnect opens)	1000	V
Housing Insulation Resistance	>1000	MΩ

Environmental Specifications

Passive Aging	+85°C, 1000 hours ±10% varistor voltage change
Humidity Aging	+85°C, 85% RH, 168 hours ±10% varistor voltage change
Thermal Shock	+85°C to -40°C 5 times ±10% varistor voltage change
Solvent Resistance	MIL-STD-202, Method 215
Moisture Sensitivity	Level 1, J-STD-020D

EVTC Series

Wave Soldering Profile

Because the EVTC Varistors contain a thermal protection device, care must be taken when soldering the devices into place. Two soldering methods are possible: 1. hand soldering: It is recommended to heat-sink the leads of the device. 2. wave-soldering: It is critically important that all preheat stage and the solder bath temperatures are rigidly controlled.

Lead-Free Profile

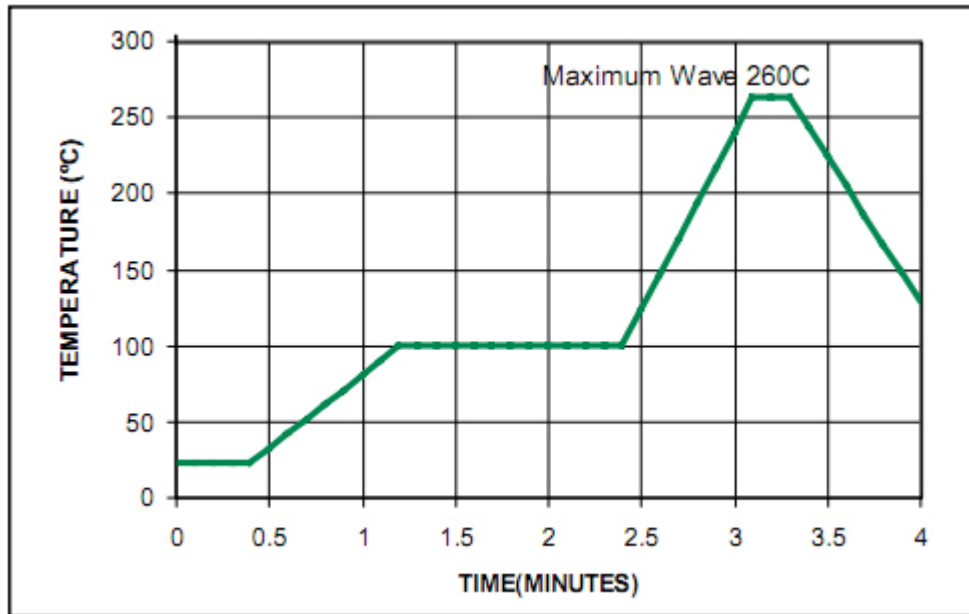

Standard Packaging

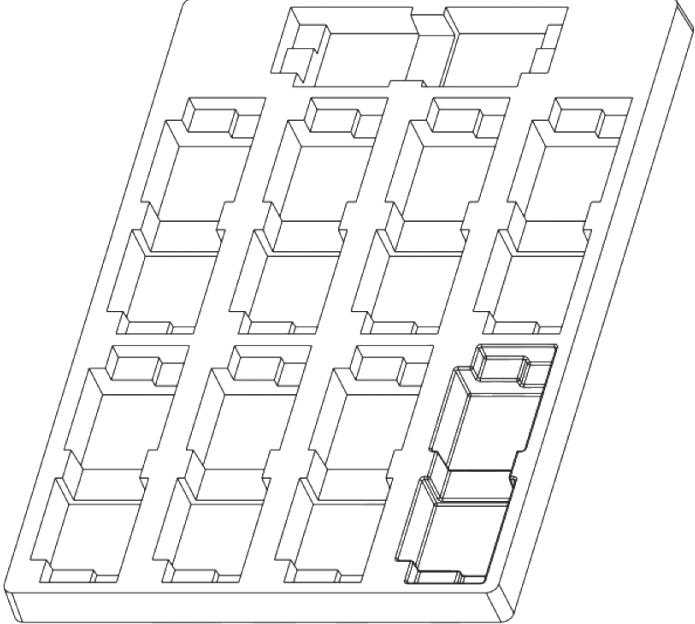
<p>Plastic Tray (345x245x20mm) 18 PCS/Plastic Tray</p>	
<p>Outside Box (350x250x150mm) 126 PCS/Carton</p>	