

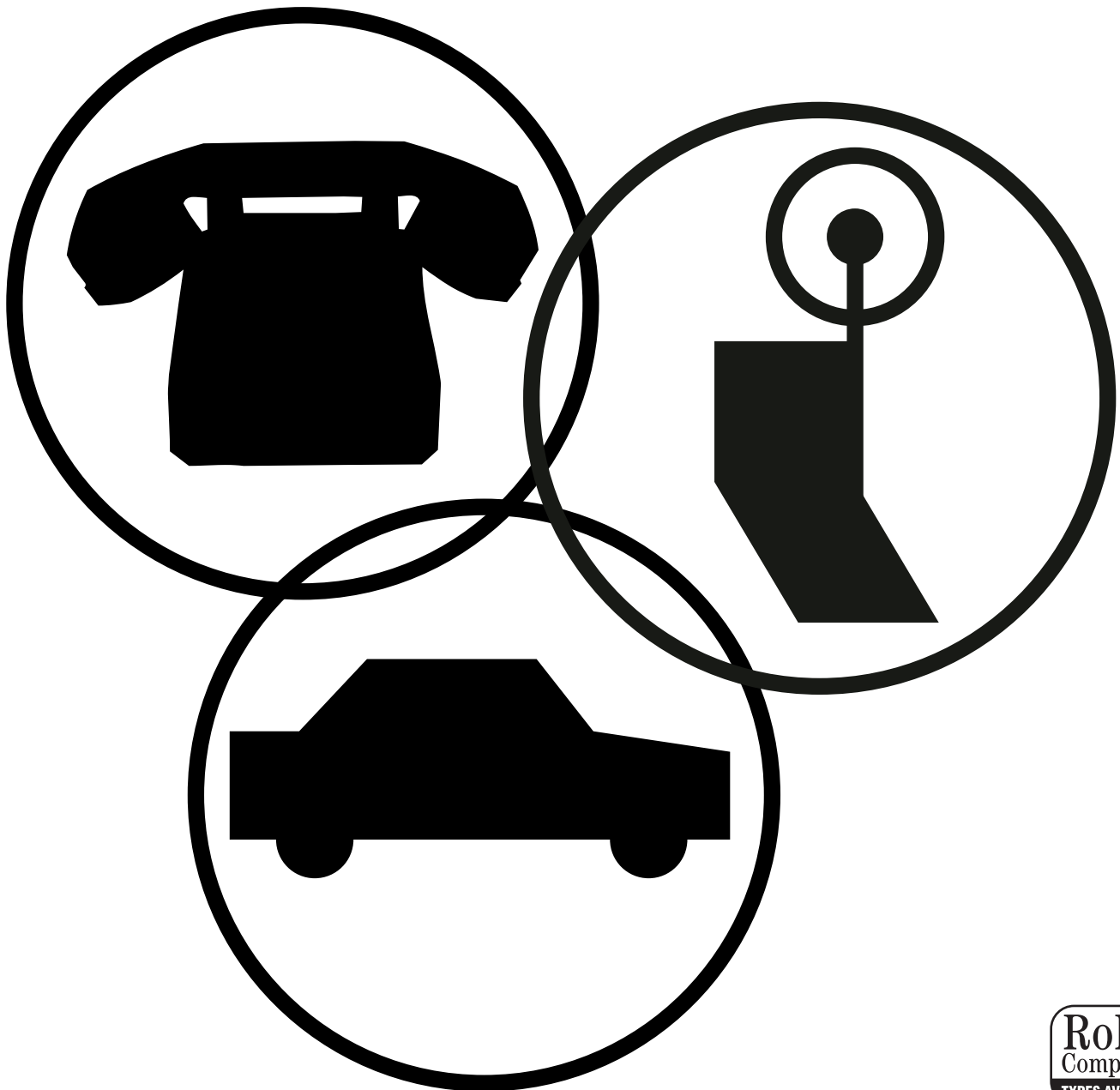

WORLD PRODUCTS INC.
ELECTRONIC COMPONENT SOLUTIONS



COMMON MODE FILTERS



CHIP COMMON MODE FILTERS

Features

1. Effective for suppressing common mode noise at high frequency from several MHz to several hundreds MHz.
2. Compact design.
3. Excellent solderability characteristics.
4. RoHS compliant with Directive 2002/95/EC of the European Parliament and of the Council of 27 January 2003 on the restriction of the use of certain hazardous substances in electrical and electronic equipment (RoHS Directive) and comply to a maximum concentration value of 0.1% by weight in homogeneous materials for lead (Pb), mercury, hexavalent chromium, polybrominated biphenyls (PBB) and polybrominated diphenyl ethers (PBDE) and of 0.01% weight in homogeneous materials for cadmium.

Applications

1. Noise suppression in digital bus line equipment.
2. IEEE1394a HUB & IEEE1394a control lines.
3. USB host controller & USB, HUB control lines.

Ordering Information

WPCMV - **2** **M** **3216** - **471** **T**
 (1) (2) (3) (4) (5) (6)

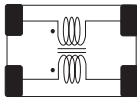

WPCML: Horizontal Design

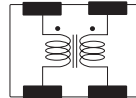

WPCMV: Vertical Design

- | | |
|--|---|
| <p>(1) Series
 WPCMV: Common mode filter for Vertical
 WPCML: Common mode filter for Horizontal</p> <p>(2) Pole Type
 2: 2 pole (single)
 4: 4 pole (double)</p> <p>(3) Material & Design
 M: Standard Thickness</p> | <p>(4) Dimensions*
 The first two digits: length(mm)
 The last two digits: width(mm)</p> <p>(5) Common mode impedance (at 100MHz)
 The first two digits are significant.
 The last digit is the number of zeros following.</p> <p>(6) Packing
 B: Bulk Packing
 T: Tape & Reel (Φ 178mm [7 inches])
 L: Tape & Reel (Φ 254mm [10 inches])</p> |
|--|---|

2012(mm) is equivalent to 0805 (inches).
 3216(mm) is equivalent to 1206 (inches).

Shape & Dimensions

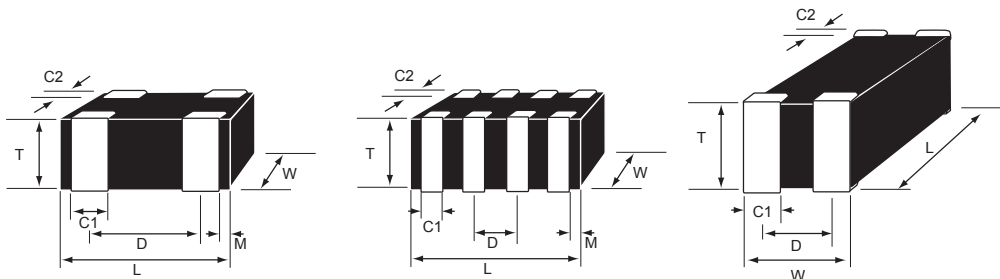

Type	L	W	T	C1	C2	D	M
WPCMV-2M2012	2.0±0.2 [.079±.008]	1.25±0.2 [.049±.008]	1.0±0.1 [.039±.004]	0.6±0.2 [.024±.008]	0.25±0.15 [.010±.006]	1.0±0.1 [.039±.004]	0.20±0.1 [.008±.004]
WPCML-2M2012	2.0±0.2 [.079±.008]	1.25±0.2 [.049±.008]	1.0±0.1 [.039±.004]	0.425±0.2 [.017±.008]	0.25±0.15 [.010±.006]	0.825±0.1 [.032±.004]	----
WPCMV-2M3216	3.2±0.2 [.126±.008]	1.6±0.2 [.063±.008]	1.3±0.1 [.051±.004]	0.7±0.2 [.028±.008]	0.3±0.2 [.012±.008]	2.1±0.2 [.083±.008]	0.20±0.1 [.008±.004]
WPCMV-4M2012	2.0±0.2 [.079±.008]	1.25±0.2 [.049±.008]	1.0±0.1 [.039±.004]	0.25±0.1 [.010±.004]	0.25±0.15 [.010±.006]	0.50±0.1 [.020±.004]	0.125±0.1 [.005±.004]
WPCMV-4M3216	3.2±0.2 [.126±.008]	1.6±0.2 [.063±.008]	1.3±0.1 [.051±.004]	0.4±0.2 [.016±.008]	0.3±0.2 [.012±.008]	0.80±0.1 [.031±.004]	0.20±0.1 [.008±.004]

CHIP COMMON MODE FILTERS

Specifications

WPCMV series (For Vertical)

Part No.	Impedance (Ω) at 100MHz Typ.	DC Resistance Max.(Ω)	Rated current Max.(mA)	Rated Voltage Max.(V)	Insulation Resistance Min.(M Ω)
WPCMV-2M2012-700T	70	0.60	400	10	100
WPCMV-2M2012-900T	90	0.70	400	10	100
WPCMV-2M2012-121T	120	0.80	400	10	100
WPCMV-2M2012-181T	180	1.00	330	10	100
WPCMV-2M2012-221T	220	1.00	330	10	100
WPCMV-4M2012-700T	70	0.80	400	5	100
WPCMV-4M2012-900T	90	0.80	400	5	100
WPCMV-4M2012-121T	120	0.90	400	5	100
WPCMV-4M2012-181T	180	1.00	330	5	100
WPCMV-4M2012-201T	200	1.00	330	5	100
WPCMV-4M2012-221T	220	1.00	330	5	100
WPCMV-2M3216-700T	70	0.50	400	16	100
WPCMV-2M3216-900T	90	0.55	400	16	100
WPCMV-2M3216-121T	120	0.60	400	16	100
WPCMV-2M3216-181T	180	0.65	330	16	100
WPCMV-2M3216-221T	220	0.70	330	16	100
WPCMV-2M3216-471T	470	0.80	250	16	100
WPCMV-4M3216-700T	70	0.60	400	10	100
WPCMV-4M3216-900T	90	0.70	400	10	100
WPCMV-4M3216-121T	120	0.80	400	10	100
WPCMV-4M3216-181T	180	0.90	330	10	100
WPCMV-4M3216-221T	220	0.90	330	10	100

WPCML series (For Horizontal)

Part No.	Impedance (Ω) at 100MHz Typ.	DC Resistance Max.(Ω)	Rated current Max.(mA)	Rated Voltage Max.(V)	Insulation Resistance Min.(M Ω)
WPCML-2M2012-700T	70	0.60	400	10	100
WPCML-2M2012-900T	90	0.70	400	10	100
WPCML-2M2012-121T	120	0.80	400	10	100
WPCML-2M2012-181T	180	1.00	330	10	100
WPCML-2M2012-221T	220	1.00	330	10	100

CHIP COMMON MODE FILTERS

Visual Dimensions

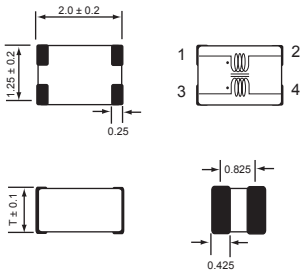

WPCML-2M2012

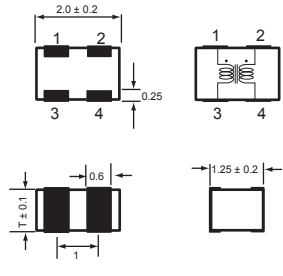

WPCMV-2M2012

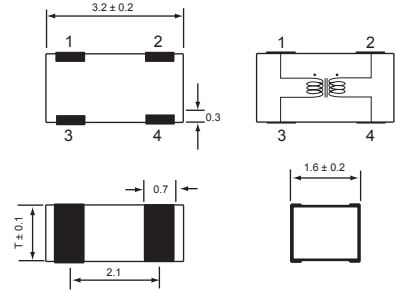

WPCMV-2M3216

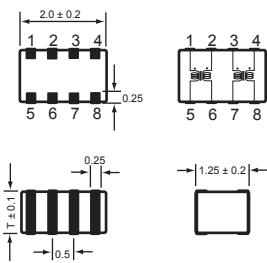

WPCMV-4M2012

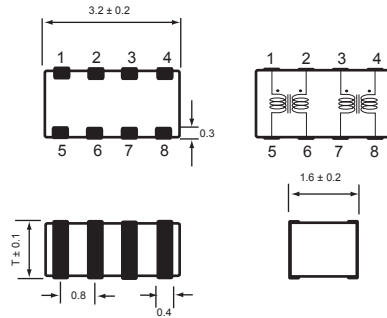

WPCMV-4M3216

Land Pattern Design

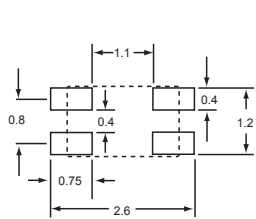

WPCML-2M2012

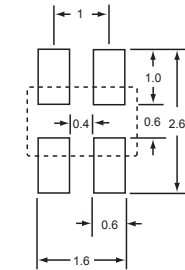

WPCMV-2M2012

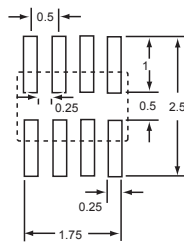

WPCMV-4M2012

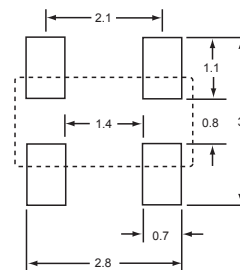

WPCMV-2M3216

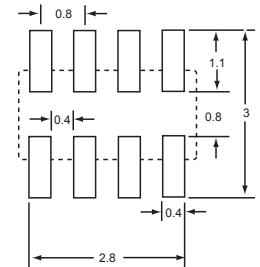

WPCMV-4M3216

CHIP COMMON MODE FILTERS

Electrical Characteristics

2012-2 Line (Single)

WPCMV-2M2012-700

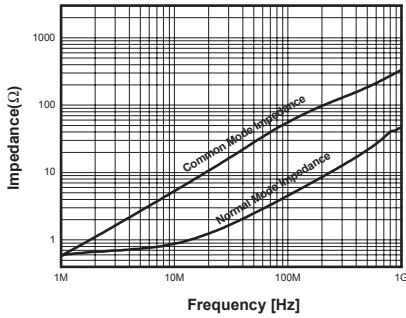

WPCMV-2M2012-900

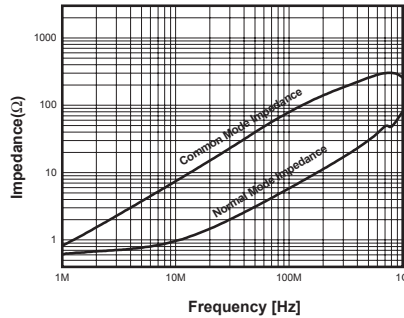

WPCMV-2M2012-121

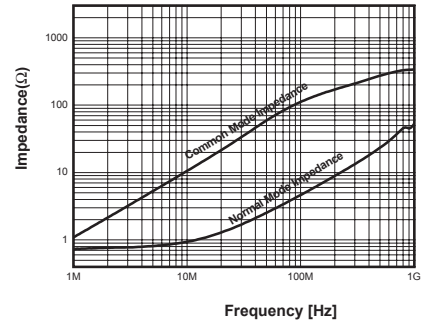

WPCMV-2M2012-181

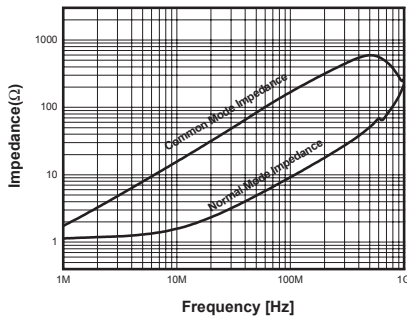

WPCMV-2M2012-221

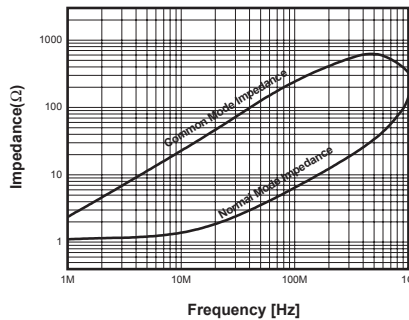

2012-4 Line (Double)

WPCMV-4M2012-700

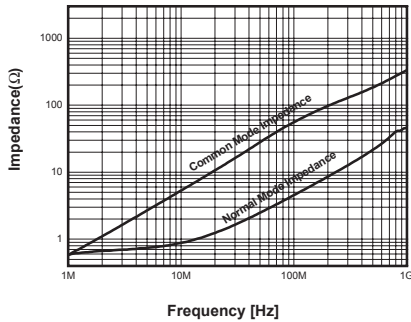

WPCMV-4M2012-900

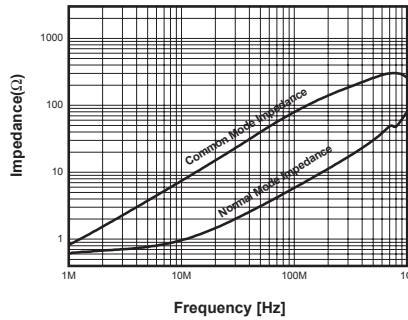

WPCMV-4M2012-121

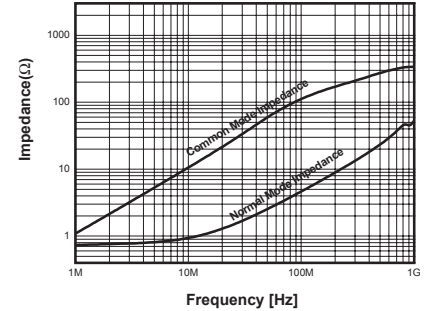

WPCMV-4M2012-181

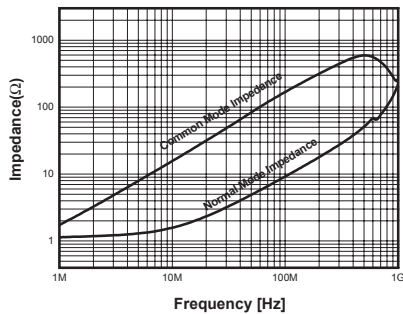

WPCMV-4M2012-201

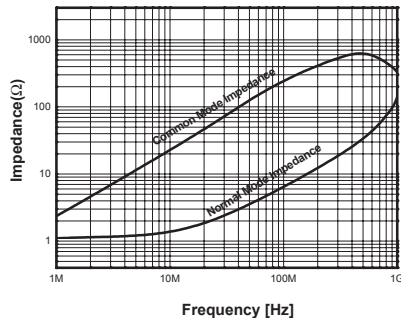

WPCMV-4M2012-221

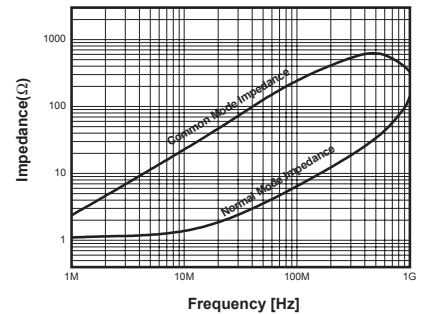

CHIP COMMON MODE FILTERS

3216-2 Line (Single)

WPCMV-2M3216-700

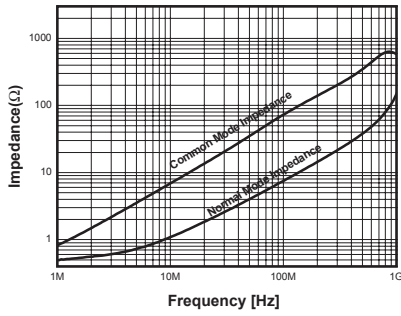

WPCMV-2M3216-900

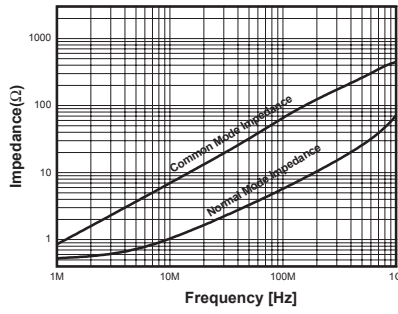

WPCMV-2M3216-121

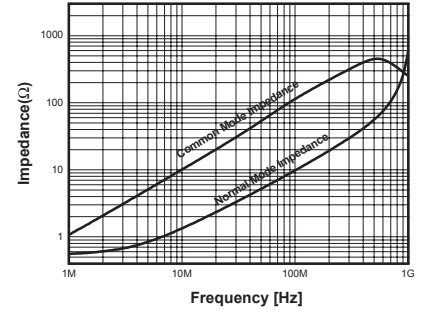

WPCMV-2M3216-181

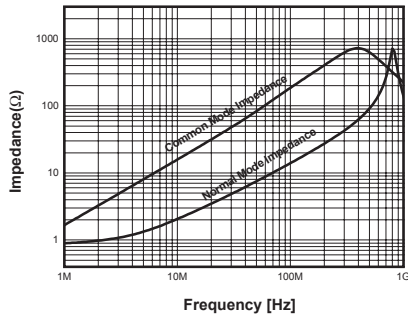

WPCMV-2M3216-221

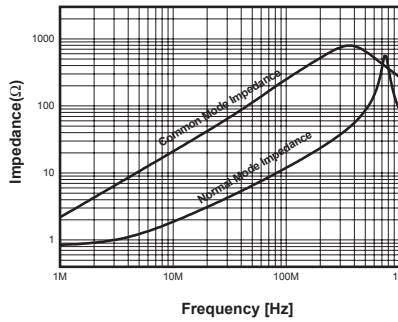

WPCMV-2M3216-471

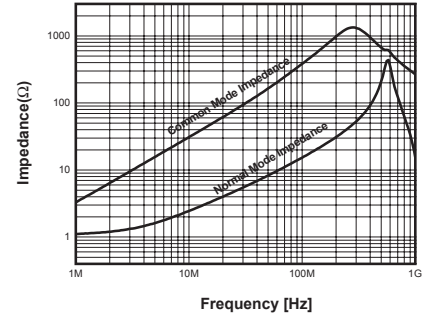

3216-4 Line (Double)

CHIP COMMON MODE FILTERS

WPCMV-4M3216-700

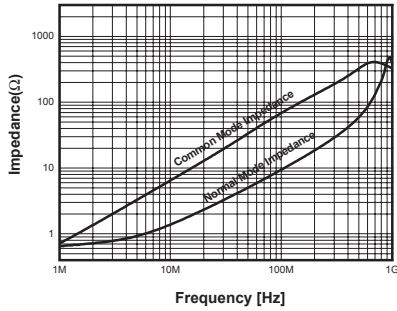

WPCMV-4M3216-900

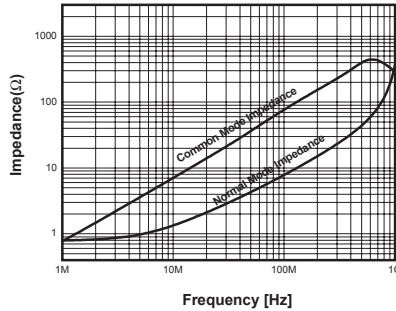

WPCMV-4M3216-121

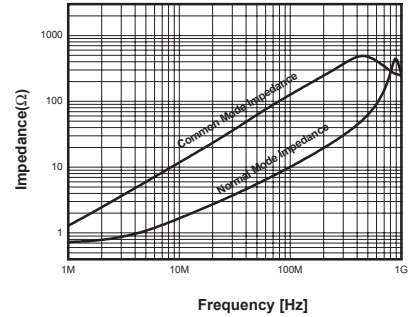

WPCMV-4M3216-181

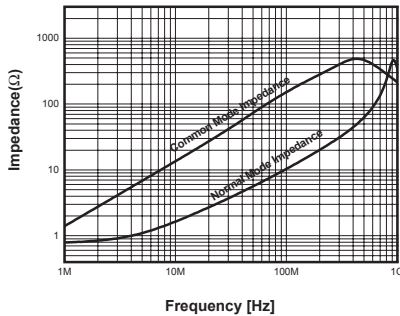

WPCMV-4M3216-221

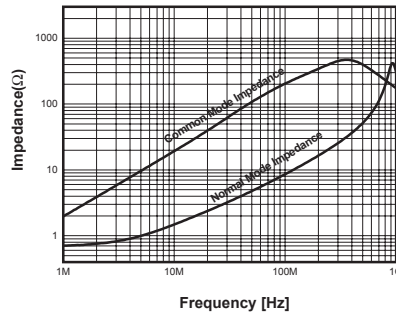

Reliability and Test Conditions

ITEM	REQUIREMENTS				TEST CONDITION
	2012 2Line	2012 4Line	3216 2Line	3216 4Line	
	WPCML	WPCMV			
Operating temp. range	-30°C~+85°C				-
Storage temp. & humidity range	40°C max. , 70% RH max.				at packing condition
Resistance to solder heat	1. No damage such as cracks should be caused in chip element. 2. More than 75% of the terminal electrode shall be covered with new solder.				Preheat temperature: 100 to 150°C Preheat time: 1min Solder temperature: 260 ±10°C Dipping time: 10 ±0.5sec.
Solderability	1. More than 90% of the terminal electrode shall be covered with new solder.				Preheat temperature: 100 to 150°C Preheat time: 1min Solder temperature: 230 ±10°C Dipping time: 3 ±1sec.
Reflow soldering	1. More than 50% of the terminal electrode shall be covered with new solder. 2. Impedance change : ±within 30% $S \geq T * 0.5$				Preheat temperature: 150°C Preheat time: 1min Solder temperature: 230°C Soldering time: 10 sec. max. (Reflow soldering profile)
Tensile strength (Terminal strength)	1. No mechanical damage.				



Unit : Kgf(W)

CHIP COMMON MODE FILTERS

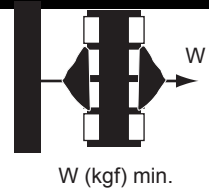

	W	1.2	1.2	1.2	1.2		
Adhesion of Terminal electrode (Flexure strength)	1.No mechanical damage						
	Unit : mm (a,b,c), Kgf(W)						
	a	0.8	1.0	0.5	2.1		0.8
	b	1.1	0.6	0.5	0.8		0.8
	c	2.6	2.6	2.5	3.0		3.0
	d	0.6	0.6	0.25	0.7		0.4
W	2.0	2.0	2.5	2.5	5.0		
Body strength (Bending strength)	1.The body shall not be damaged by forces applied on the right.						
	Unit : mm (d), Kgf(W)						
	d	1.3	1.3	2.0	2.0		2.0
W	2.0	2.0	3.0	3.0	3.0		

Reliability and Test Conditions (cont'd)

ITEM	REQUIREMENTS				TEST CONDITION
	2012 2Line	2012 4Line	3216 2Line	3216 4Line	
Drop	1. No mechanical damage.				Drop 10 times on a concrete floor from a height of 91cm
Vibration	1. No mechanical damage.				Frequency : 10~55~10Hz Amplitude : 1.52mm Direction and time : X,Y,Z directions for 2 hours
Thermal shock (Temperature cycle)	1. No mechanical damage. 2. Impedance change: ±within 30%.				Step1. -40 ±3°C 30 ±3min. Step2. 85 ±3°C 30 ±3min. Number of cycle : 100 times Measured at room ambient temperature after placing for 24 hours
Heat load resistance	1. No mechanical damage. 2. Impedance change: ±within 30%.				Temperature : 85 ±2°C Applied current : rated current Time : 1,000 hours Measured at room ambient temperature after placing for 24 hours
Low temp. resistance	1. No mechanical damage. 2. Impedance change: ±within 30%.				Temperature : -40 ±5°C Time : 1,000 hours Measured at room ambient temperature after placing for 24 hours

CHIP COMMON MODE FILTERS

Humidity resistance	<ol style="list-style-type: none"> 1. No mechanical damage. 2. Impedance change: \pmwithin 30%. 	Temperature : 40 \pm 2°C Humidity : 90~95% RH Time : 500 hours Measured at room ambient temperature after placing for 24 hours
Humidity load resistance	<ol style="list-style-type: none"> 1. No mechanical damage. 2. Impedance change: \pmwithin 30%. 	Temperature : 40 \pm 2°C Humidity : 90~95% RH Applied current : rated current Time : 500 hours Measured at room ambient temperature after placing for 24 hours

CHIP COMMON MODE FILTERS

Labeling

Label

- 1) Part name.
- 2) Lot No.
- 3) Quantity.

Standard quantity for packing

Packing Type(EIA)	Tape & Reel			Bulk
	Reel	Inner box	Carton box	Vinyl or Cassette
2012	3,000	30,000	120,000	As wanted
	7,000	70,000	280,000	
3216	3,000	30,000	120,000	
	7,000	70,000	280,000	

* Packing method can be changed, based on user's request.

Tape Dimension

Embossing 8mm

Type	A ± 0.1	B ± 0.1	P ± 0.1	K0 ± 0.1	T (max.)
WPCMM - MM2012	1.45	2.25	4.0	1.35	0.3
WPCMM - ML2012				1.00	
WPCMM - MM3216	1.90	3.60	4.0	1.75	0.3
WPCMM - ML3216				1.35	

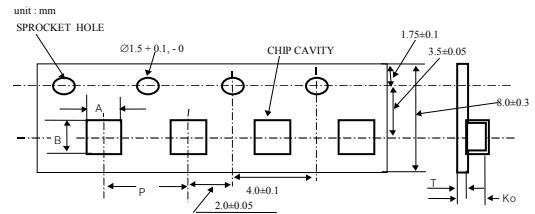

Leader and Blank Portion

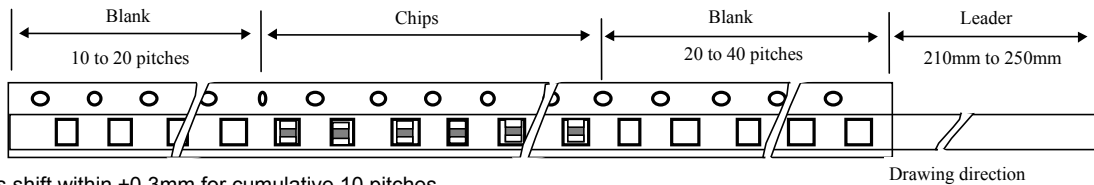

The pitch holes shift within ±0.3mm for cumulative 10 pitches.

Reel Dimension

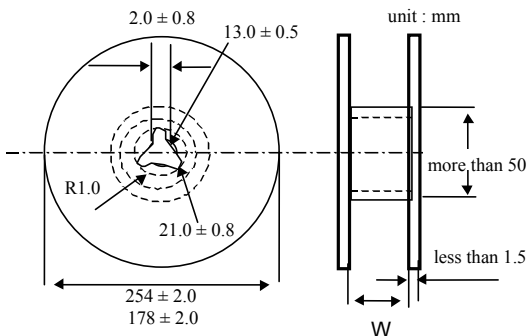

Type	W (mm)
2012, 3216	9.0 ± 0.3

CHIP COMMON MODE FILTERS

Top Cover Tape Strength

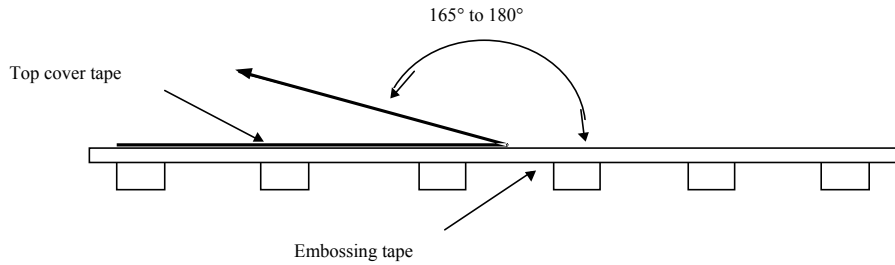

The force for tearing off top cover tape is 20 to 70 grams in the arrow direction.

Soldering Profile

REFLOW SOLDERING PROFILE(Peak 230°C)

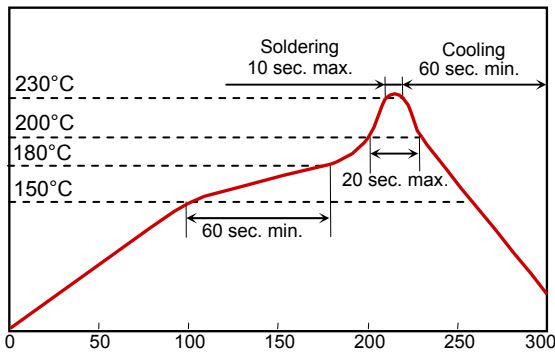

REFLOW SOLDERING PROFILE(Peak 250°C)

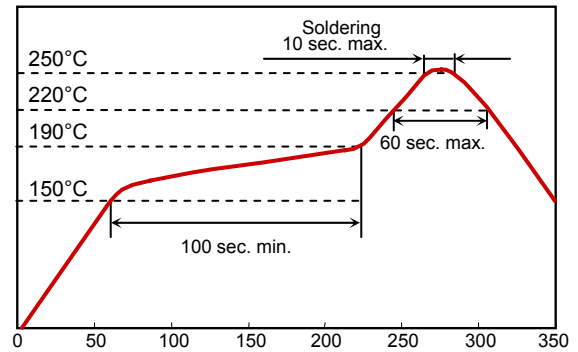

FLOW SOLDERING

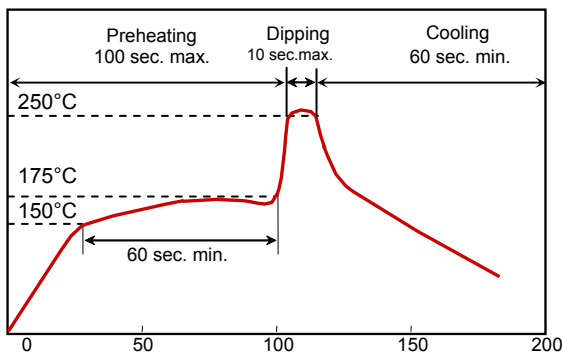

MANUAL SOLDERING

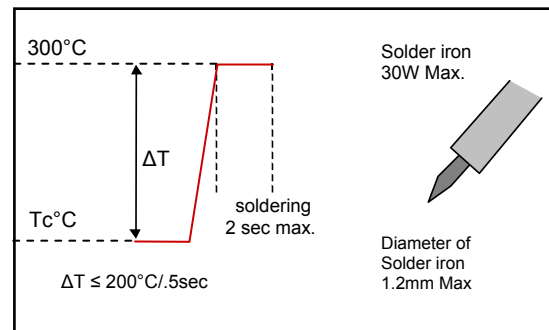

DISCLAIMER: The names of the products and the specifications in this catalog are subject to change without notice for the sake of improvement. World Products Inc. also reserves the right to discontinue any of these products. The products in this catalog are intended for use in ordinary electronic products. If any of these products are to be used in special applications requiring extremely high reliability, where product defects might pose a safety risk, please consult World Products Inc. Though World Products Inc. has taken all possible precautions to ensure the quality and reliability of its products, improper use of products may result in bodily injury, fire, or similar accident. If you have any questions regarding the use of the products in question, please consult World Products Inc. Please be advised that World Products Inc. accepts no responsibility for any infringement by users of World Products Inc. products on third party patents or industrial copyrights.